

C785S-IM-AA

3.5" form factor, Intel® Core™ i7-8565U Processor, DDR4 SO-DIMM, DP, HDMI, LVDS, Dual-LAN, Multiple COM, 12-24V DC

Features

- Up to 6 COM ports, includes 2 x RS-232/422/485
- Supports 3 display configuration by multiple interface: DP/HDMI/LVDS
- Supports I²C, SMBus and DIO
- Wide temperature range endurance: -20~60 °C

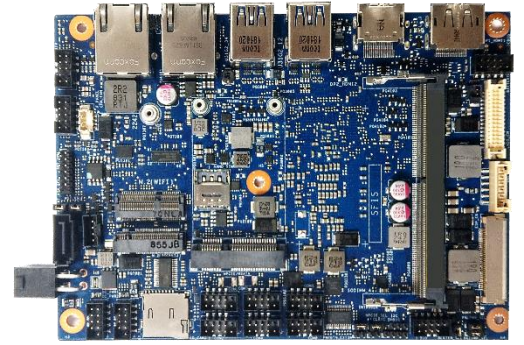

Specifications

CPU	Intel® Core™ i7-8565U Processor (SoC), 1.8GHz Quad-core, 8MB Cache
Chipset	Integrated
Memory	1 x SO-DIMM, max. 16GB, DDR4 2400/2133 MHz, non-ECC, un-buffered memory
Expansion Slots	1 x M.2 Socket 1 with E key, type 2230 for WIFI/BT device 1 x M.2 Socket 3 with M key, type 2242 (PCIe x2 mode & SATA mode) 1 x Full-Length Mini PCIe slot with an on-board Nano-SIM socket
Storage	1 x SATA 6Gb/s connector 1 x mSATA slot (shared with Mini PCIe) 1 x Micro SD Card slot (on-board)
Display	Multi-VGA output support :DP/HDMI/LVDS ports Supports up to 3 displays simultaneous under OS
USB	4 x USB3.1 Gen2 Type-A ports 2 x USB2.0 headers support additional 4 x USB2.0 connectors
Serial Port	6 x COM headers (2 x RS-232/422/485, 4 x RS-232)
Internet	Dual RJ45 connectors (1 x Intel® I219V, 1 x Intel® I211AT)
Audio	Realtek ALC887-VD2 High Definition Audio CODEC
Internal I/O	1 x Chassis fan header 1 x Chassis intrusion header 1 x Front panel audio header (AAFP) 1 x System panel header 1 x Clear CMOS jumper 1 x SATA power header 1 x LPC Debug header 1 x SMBus header 1 x I ² C header 1 x 4-pin power connector
GPIO	1 x 8bit GPIO header
TPM	1 x TPM header
BIOS	128 Mb Flash ROM, UEFI AMI BIOS, PnP, DMI 2.0, WfM 2.0, SM BIOS 3.0, ACPI 6.0, Multi-language BIOS, ASUS EZ Flash 3, Last Modified Log, ErP
Watch dog timer	Yes
Power requirement	12-24V DC input
Operation Temperature	-20~60°C
Non-Operation Temperature	-40~85°C
Relative Humidity	0%~85%
Operating System Support	Windows® 10 (64-bit) / Windows® 10 IoT Enterprise / Linux
Form Factor	3.5", 146 x 105 mm

Block Diagram

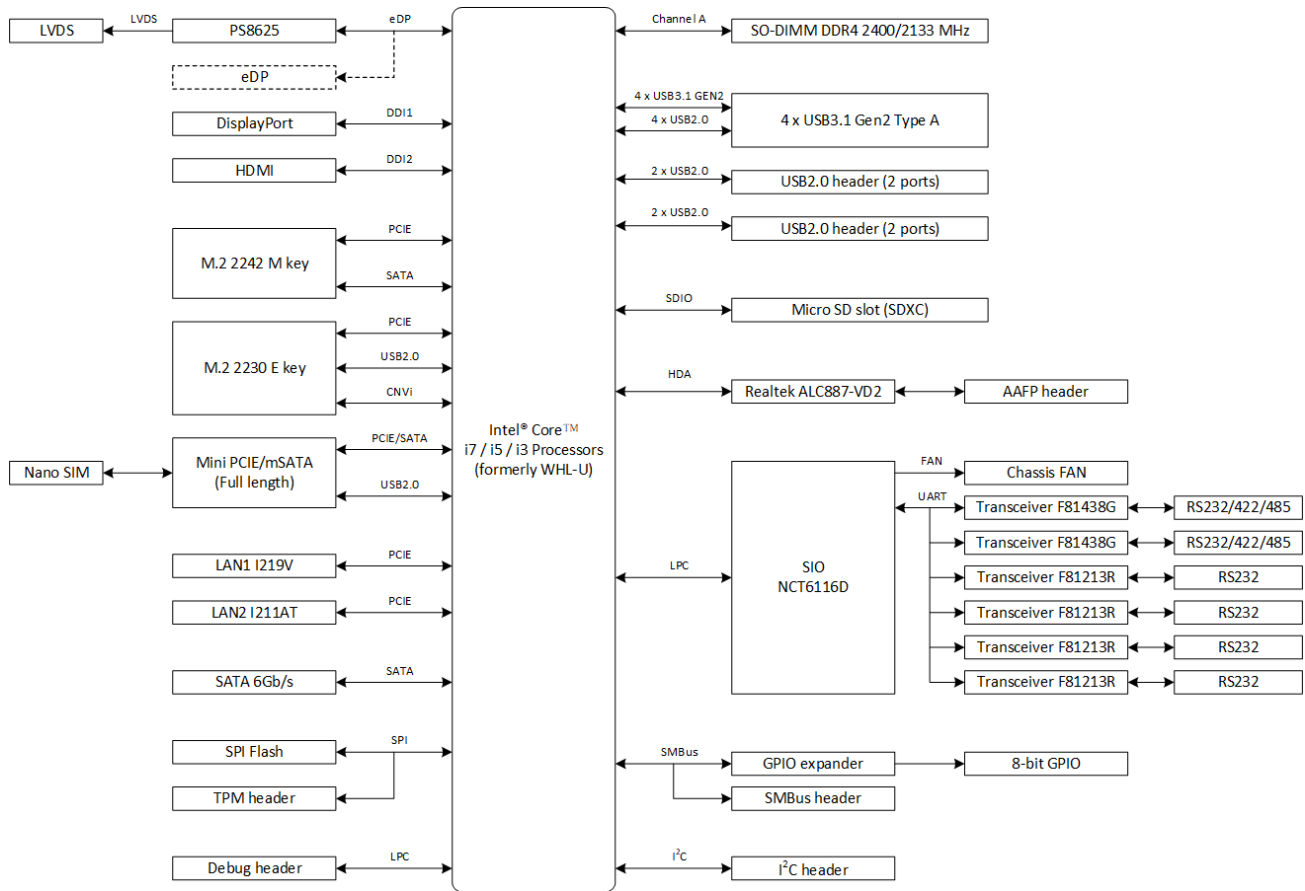

Ordering Information

Model Name	Description
C785S-IM-AA	3.5" form factor, 8th Gen Core™ i7-8565U Processor, DDR4 SO-DIMM, DP, HDMI, LVDS, Dual-LAN, Multiple COM, 12-24V DC

Optional Accessories

Part Number	Description
14011-03700400	COM Port Cable, 1 Port, 28mm
14013-00260000	SATA cable with SATA power
14011-03740000	Power Button Cable with LED
14011-03750000	USB 2.0 Cable, 2 ports, 70mm

Packing List

Part Number	Description
15000-	M.2 screw pack
15000-	Driver DVD